

SketchUp Math Project: Grades 10 - 12

This project works in any version of SketchUp.

It's amazing what you can make when you start with the famous rectangle known as the "golden section." Here are three such objects.

For basic information on downloading SketchUp, as well as its user interface and basic tools, please see our printable "Intro to SketchUp" PDF: www.3dvinci.net/SketchUp_Intro.pdf.

1. Use the **Rectangle** tool to draw a golden section on the ground (red-green plane).

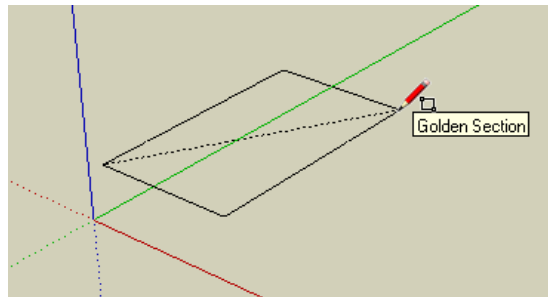

2. It's easiest to complete this project if the rectangle is centered at the origin. So use **Move** to place it there. The easiest way to do this is to grab the rectangle by a midpoint and place the midpoint at the origin. Then slide the rectangle over by grabbing a midpoint on an adjacent edge and dragging it in the correct axis direction.

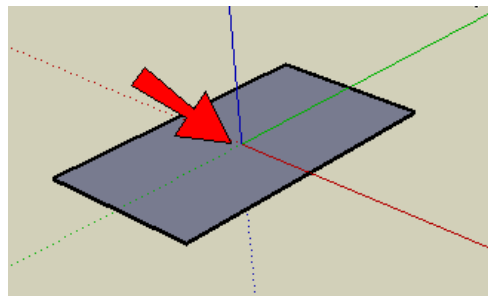

3. Rotate-copy the rectangle once, then rotate the copy, to get this. (Having the center at the origin makes rotating much easier.)

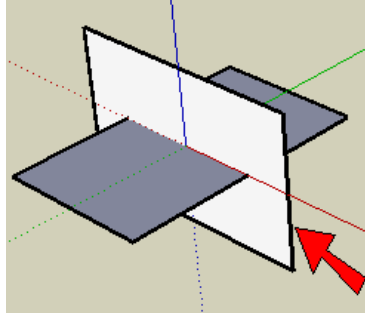

4. Repeat the last step in the other direction. Now you should have three golden rectangles that are all centered at the origin.

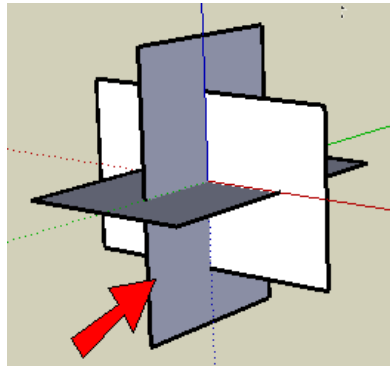

5. Use **Line** to connect a corner point of one rectangle to the two corners of the edge closest to it. This makes your first triangle, which is equilateral (all sides equal).

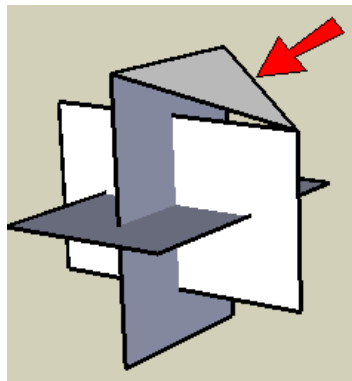

6. Create the rest of the triangles the same way. There should be 20 triangles in all. You've just made an icosahedron.

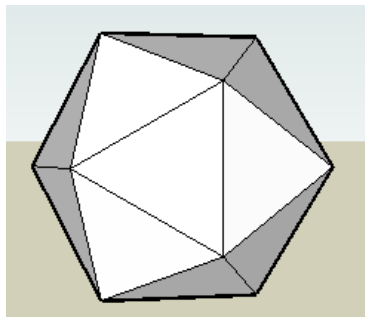

7. Here's a challenge: color the icosahedron using only five colors, so that no color is repeated at any corner.

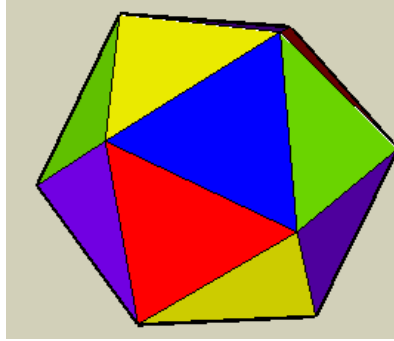

8. Make a copy of the icosahedron, and on this copy erase each of the 20 triangles. You will have this object, where each “main” face is a pentagon with a star sticking out of it. Another challenge: color these faces using only six colors, so that each pentagon / star face has no repeating colors.

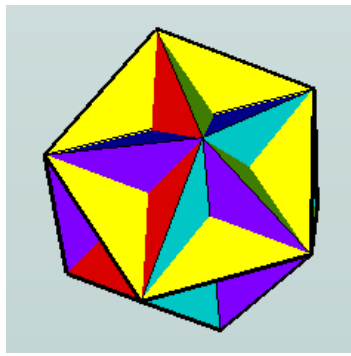

This object is called a “great dodecahedron” (<http://mathworld.wolfram.com/GreatDodecahedron.html>). Another great (and complicated!) project is to “unfold” it, using the methods described in the Math Project for Grades 6-9.

9. We'll do one last thing with the icosahedron (make a copy or use the original one). On one of the triangles faces, make a hexagon. To do this, you can divide each triangle edge into three segments, by right-clicking on each edge and choose **Divide**. Then you can connect the endpoints of these new segments.

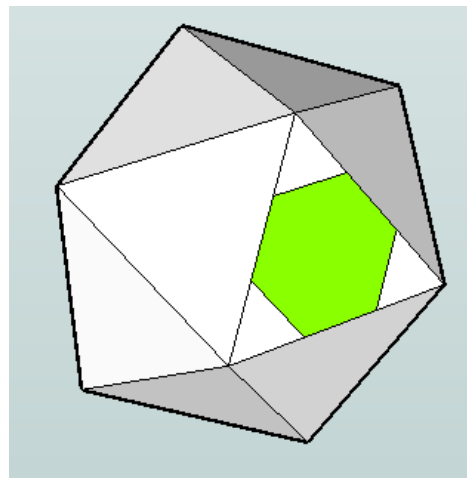

10. Copy this hexagon to the other 19 faces. Use the **Rotate** tool for this, using the click-and-drag method to set the rotation axis. Remember to use the Ctrl / Option key to make copies.

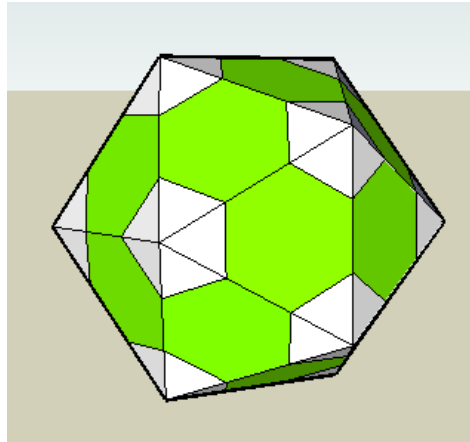

11. You now have five sets of triangles between each ring of five hexagons. Erase the edges of these triangles, and use **Line** to replace the face where you're left with a hole. This new face is a pentagon.

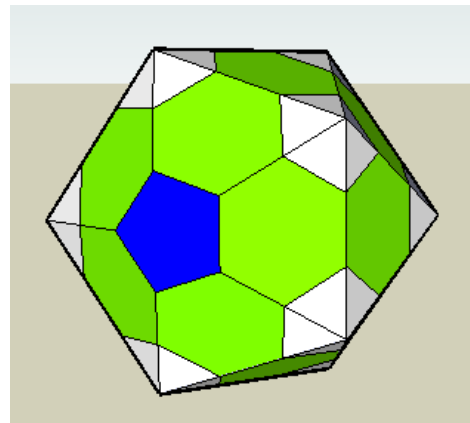

12. Do this at every corner, until you have filled in all 12 pentagons. Behold: a soccer ball! (Or bucky ball, or football if you're outside the US.)

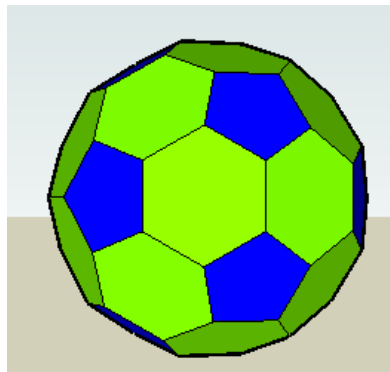

There is no limit to what you can create with a set of three golden sections. And for more advanced users, if you understand about components and scaling, you can complete these projects a bit faster.

If you like this project, please check out 3DVinci's *GeomeTricks Series* (<http://www.3dvinci.net/ccp0-catshow/GM.html>). The books shown below are appropriate for this age group, and teach how to create Platonic and Archimedean solids, as well as some amazing derivative compounds and other objects.

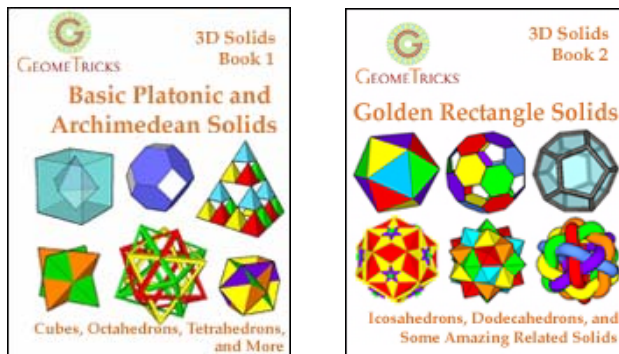

All of the models in the Teacher Guide can be downloaded from Google's 3D Warehouse:
<https://3dwarehouse.sketchup.com>.

- Click [this link](#) to see the entire Warehouse collection of models used in the Teacher Guide.
- Click [this link](#) to locate this exact house model in the Warehouse.

If you're reading this as a printed PDF and can't click on the links, here's how to find the Teacher Guide models:

1. Open the 3D Warehouse.
2. In the **Search** field, type "teacher guide" then click the gear icon and click "Search for collections." Press Enter or click the **Search** button.

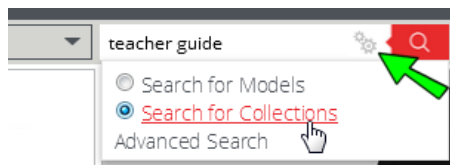

3. Open this collection:

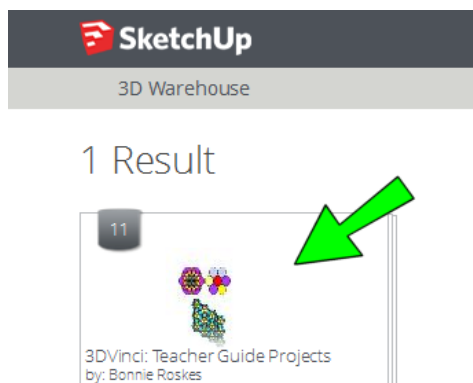

4. In the collection, find the model you want, and open or download it.